

PART CATALOGUE



CONTENTS

Hollanderes-vágógyűrűs csatlakozók.....	4
1. Könyök 90° bekötő csatlakozók.....	4
2. Egyenes bekötő csatlakozók.....	4
5	
3. Forgó bekötőelem.....	Hiba! A könyvjelző nem létezik.
4. Forgó csatlakozó, BANJO type	Hiba! A könyvjelző nem létezik.
5. Forgó csatlakozó T-elem, BANJO type	Hiba! A könyvjelző nem létezik.
Hollanderes-vágógyűrűs toldók és kiegészítők.....	6
1. Toldó elem	Hiba! A könyvjelző nem létezik.
2. T-csatlakozók.....	Hiba! A könyvjelző nem létezik.
3. Hollanderek	Hiba! A könyvjelző nem létezik.
4. Vágógyűrűk	7
Visszacsapó szelepek, falátvezetők	7
1. Visszacsapó szelepek	Hiba! A könyvjelző nem létezik.
2. Falátvezetők.....	Hiba! A könyvjelző nem létezik.
Gyorskuplungos (Push-in) csatlakozók	8
1. Könyök 90° csatlakozók	8
2. Egyenes csatlakozók	8
3. Könyök 90° csatlakozók 360°-ban elforduló.....	8
4. Gyorscsatlakozós toldó elem	9
Magasnyomású, flexibilis tömlők és szerelési anyagok	9
1. Magasnyomású tömlők.....	Hiba! A könyvjelző nem létezik.
9	
2. Csővégek (vasalatok) flexibilis tömlőkhöz (2-3-3a) tételek).....	9
3. Egyenes csőszárak.....	10
10	
10	
10	
4. 90° és 45°-os csőszárak.....	10
11	
5. Műanyag és fémcsővek, kenővezetékek	11
.....	11
Zsírzó blokkok	11
.....	11
Záródugók	Hiba! A könyvjelző nem létezik.
Töltőcsatlakozók, zsírzógombok.....	12

Adapterek, kiemelők és menet átalakító elemek	13
13	
1. Szorítóhüvelyek és DD vágógyűrűk	13
2. 45°Adapterek	14
14	
3. 90°Adapterek	14
4. Csőbilincsek	Hiba! A könyvjelző nem létezik.
Csővédő, lépésálló csőbandázs	14
Elektro-kémiai adagolású kenőpatronok.....	14
1. PULSARLUBE „S”	15
<i>Rugós zsírzó, -23°C + 120°C, 1/4" csatlakozás, d67mm x 129mm</i>	15
15	
<i>Gázos, 1-3-6-12 hónap, -20°C + 55°C, 5bar, EX T4 + IP65</i>	15
.....	16
Elektro-mechanikai adagolású kenőpatronok.....	16
1. PULSARLUBE „M”	16
<i>Elektro-mechanikus, -15°C +60°C Alkáli; -40°C +60°C Lithium, 1/2 - 24 hónap, 30/60 bar, IP54</i>	16
a) Kíttek PULSARLUBE „M” – töltve	16
2. PULSARLUBE „MSP” - Kíttek.....	16
<i>Szinkronizált verzió – KÜLSŐ TÁPEGYSÉG, AC 110- 440V 0,5W vagy DC 24V, 5,0V 2A output signal, Red-LED display "ON"</i> 16	
3. PULSARLUBE "OL"	16
<i>Olajkenő, -15°C +60°C Alkáli, -40°C + 60°C Lithium, 1/2 - 24 hónap, 10bar, 150-10000 cSt</i>	16
Automata Kenőrendszerek	19
1. Dropsa Bravo kenőszivattyú.....	19
<i>Szállítás: 2,8ccm/min, 9 - 36V unipoláris, min. 3 kg, timer/ciklus vezérlés</i>	19
2. Lincoln P203 kenőszivattyú	19
<i>Szállítás: 2,8ccm/min, 12V vagy 24V, min. 2 kg, timer-idővezérlés</i>	19
3. Bekamax EP 1 kenőszivattyú.....	19
<i>Szállítás: 1,7 ccm/min, 12V vagy 24V, min. 1,9 kg, timer-idővezérlés</i>	19
4. Vogel KFGS kenőszivattyú (Komatsu, Caterpillar)	19
<i>Szállítás: 1,7 ccm/min, 12V vagy 24V, min. 3 kg, timer-idővezérlés</i>	19
Automata kenőrendszerek egyéb alkatrészei	20
1. Egyéb kiegészítők	Hiba! A könyvjelző nem létezik.
Kenőanyagok	21
1. Kenősírok.....	Hiba! A könyvjelző nem létezik.
2. Kenőolajok	Hiba! A könyvjelző nem létezik.
Kiegészítő információk.....	Hiba! A könyvjelző nem létezik.

- Az árak nettó – 27% ÁFA nélküli – egységárak, fco. Kecskemét.....	22
- A megrendelés darabonként vagy folyóméterben, jelölve egységcsomagban adható fel.....	22
- Az árlista a csomagolás és a szállítás költségeit nem tartalmazza	22
▪ Postaköltség: megkezdett 10 kg-onként 1800 Ft + ÁFA (5,50 €)	22
▪ Egy csomag súlya max. 40 kg	Hiba! A könyvjelző nem létezik.
- Szállítási határidők:	22
▪ Standard termékek esetén max. 1 hét	22
- Feladás naponta – a 13 óráig beérkezett megrendeléseket a raktárkészlet erejéig még aznap feladjuk, GLS futárral.	22
Megrendelések feladása.....	22
- emailben info@euroscale.hu	22
- webshopon www.euroscale.hu	Hiba! A könyvjelző nem létezik.
<i>A megrendelésben a cikkszámot és a rendelt darabszámot kérjük feltüntetni!</i>	22
Információs telefonszám a pontos kiválasztáshoz:	22
+3670 621 0346 vagy +3670 341 5067	22
További alkatrészek/szolgáltatások egyedileg rendelhetőek meg:	22
- Kenőrendszer diagnosztikai vizsgálat: szivattyú és elosztók bemérése, felülvizsgálata, dugulások elhárítása	22
Keresse fel online katalógusunkat, ahol részletesebben és bővebben tájékozódhat kínálatunkról. Hiba! A könyvjelző nem létezik.	
WWW.ZSIRZOALKATRESZ.HUHiba! A könyvjelző nem létezik.	
További, kiegészítő termékeinkért keressen minket!.....	22

Cutting ring fittings

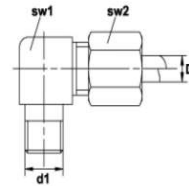

1. Elbow (90°) fittings

Part Number	Description	Tube diameter	d1	Sw1	Sw2	Price (EUR)
104-101	WE 4-LL M6x1	4	M6x1	9	10	2,88 €
104-102	WE 4-LL M8x1	4	M8x1	9	10	2,88 €
104-103	WE 4-LL M10x1	4	M10x1	11	12	2,88 €
104-104	WE 4-LL R1/8 BSP	4	R 1/8"	11	12	2,88 €
106-101	WE 6-LL M6x1	6	M6x1	11	12	2,23 €
106-102	WE 6-LL M8x1	6	M8x1	11	12	1,97 €
106-103	WE 6-LL M10x1	6	M10x1	11	12	2,13 €
106-104	WE 6-LL R1/8 BSP	6	R 1/8"	11	12	2,13 €
106-105-L	WE 6-LL R1/4	6	R 1/4"	12	14	6,32 €
106-101-VA**	WE 6-LL M6x1	6	M6x1	11	12	Ask
106-102-VA**	WE 6-LL M8x1	6	M8x1	11	12	Ask
106-103-VA**	WE 6-LL M10x1	6	M10x1	11	12	Ask
106-104-VA**	WE 6-LL R1/8 BSP	6	R 1/8"	11	12	Ask

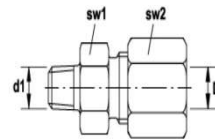

2. Straight fittings

Part Number	Description	Tube diameter	d1	Sw1	Sw2	Price (EUR)
104-001	GE 4-LL M6x1	4	M6x1	9	10	1,31 €
104-002	GE 4-LL M8x1	4	M8x1	9	10	1,31 €
104-003	GE 4-LL M10x1	4	M10x1	11	12	1,31 €
104-004	GE 4-LL R1/8 BSP	4	R 1/8"	11	12	1,31 €
106-001	GE 6-LL M6x1	6	M6x1	11	12	1,03 €
106-002	GE 6-LL M8x1	6	M8x1	11	12	1,03 €
106-003	GE 6-LL M10x1	6	M10x1	11	12	0,82 €
106-004	GE 6-LL R1/8 BSP	6	R 1/8"	11	12	1,03 €
106-005-L	GE 6-LL R1/4	6	R 1/4"	12	14	2,91 €
106-001-VA	GE 6-LL M6x1	6	M6x1	11	12	Ask
106-002-VA	GE 6-LL M8x1	6	M8x1	11	12	Ask
106-003-VA	GE 6-LL M10x1	6	M10x1	11	12	Ask
106-004-VA	GE 6-LL R1/8 BSP	6	R 1/8"	11	12	Ask
108-001	GE 8-LL M6x1	8	M6x1	14	14	2,03 €
108-002	GE 8-LL M8x1	8	M8x1	14	14	2,03 €
108-003	GE 8-LL M10x1	8	M10x1	14	14	2,03 €
108-004	GE 8-LL R1/8 BSP	8	R 1/8"	14	14	2,03 €



3. Swivel unions

Part Number	Description	Tube diameter	d1	Sw1	Sw2	Price (EUR)
106-123	Swivel union 10x1	6	10X1	12	14	10,50 €
106-124	Swivel union 1/8"	6	1/8"	12	14	10,50 €

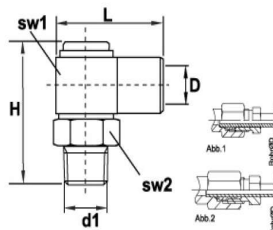

4. Banjo fittings freely movable, 90°

Part Number	Description	Tube diameter	D	d1	Sw1	Sw2	H	L	Price (EUR)
104-172	Movable elbow banjo 8x1	4	8x1	8x1	15	14	30	26,5	14,92 €
104-173	Movable elbow banjo 10x1	4	8x1	10x1	15	14	30	26,5	14,92 €
106-171	Forgó könyök csatlakozó	6	10x1	6x1	15	14	30	29	14,92 €
106-172	Movable elbow banjo 8x1	6	10x1	8x1	15	14	30	29	14,92 €
106-173	Movable elbow banjo 10x1	6	10x1	10x1	15	14	30	29	14,92 €
106-174	Movable elbow banjo 8x1	6	10x1	1/8"	15	14	30	29	14,92 €

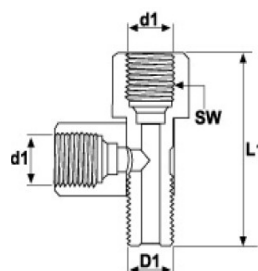

5. T-Banjo fittings

Cikkszám	Leírás	D1	d1	SW	Ár / Price
Part Number	Description				EUR
100-323	T-Banjo fitting 10x1	10X1	10X1	14	6,81 €
100-324	T-Banjo fitting 1/8"	1/8"	10X1	14	6,81 €

Hollanderes-vágógyűrűs toldók és kiegészítők

1. Straight connectors

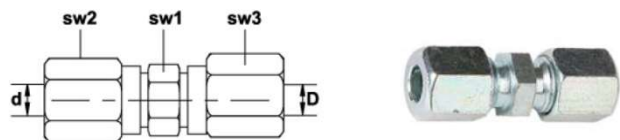

Part Number	Description	Tube diameter	Tube diameter	Sw1	Sw2	Sw3	Price (EUR)
104-000	G 4-LL	4	4	9	10	10	2,23 €
104-000-6	G 4-LL / G 6-LL	4	6	11	10	12	2,66 €
106-000	G 6-LL	6	6	11	12	12	1,81 €
106-000-8	G 6-LL / G 8-LL	6	8	12	12	124	3,22 €
106-000-10	G 6-LL / G 10-LL	6	10	17	14	19	3,47 €
108-000-L	G 8-L	8	8	12	17	17	2,91 €
110-000-L	G 10-L	10	10	17	19	19	3,47 €
104-000-VA	G 4-LL	4	4	9	10	10	Ask
106-000-VA	G 6-LL	6	6	11	12	12	Ask
108-000-VA-L	G 8-L	8	8	14	17	17	Ask
110-000-VA-L	G 10-L	10	10	17	19	19	Ask

2. Equal tee connectors

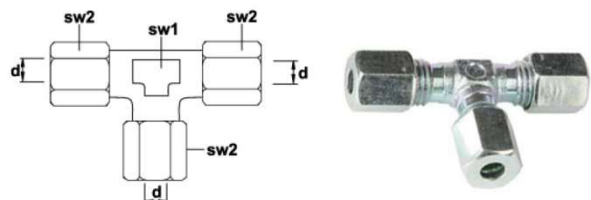

Part Number	Description	Tube diameter	Sw1	Sw2	Price (EUR)
104-300	T 4-LL	4	9	10	7,00 €
106-300	T 6-LL	6	11	12	7,06 €
106-300-L	T 6-LL	6	12	14	8,66 €

3. Coupling nuts



Part Number	Description	Tube diameter	Sw1	Price (EUR)
104-200	4MM	4	9	0,30 €
106-200	6MM	6	12	0,30 €
106-200-SW	6MM black	6	12	0,25 €
106-200-VA	6MM	6	12	Ask
108-200	8MM	8	14	0,59 €
110-200-L	10MM	10	19	0,49 €

4. Cutting rings



Part Number		D	Serie	Ár / Price
104-210	4MM	4	LL	0,34 €
106-210	6MM	6	LL	0,25 €
106-210-VA	6MM	6	LL	Ask
108-210	8MM	8	LL	0,47 €
110-210-L	10mm	10	L/S	0,50 €

Non-return valves, Bulk heads

1. Non-return valves

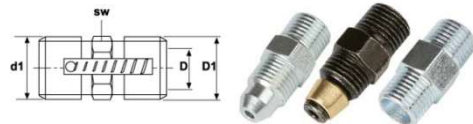

Part Number	Description	Tube diameter	Tube diameter	D1	Sw	Price (EUR)
106-033-RVB	RVB M10X1 BODY	M10x1	6	M10x1	11	2,16 €
106-033-RVL	RVL M10X1 BODY	M10x1	6	M10x1	11	1,66 €
106-033-RVV	RVV M10X1 BODY	M10x1	6	M10x1	11	1,80 €
106-033-RVV-VA	RVV M10X1 VA BODY	M10x1	6	M10x1	11	18,84 €
92335	SMX	R 1/8"	6	R 1/8"	12	6,50 €
644776	SMP-M	M8x1	4	5/16"	10	3,99 €

Additional parts:

- 106-200-SW coupling nut
- 106-210 cutting ring

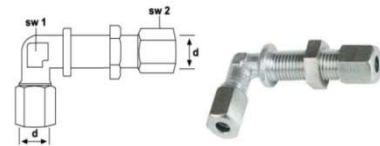

2. Bulk heads



Part Number	Description	Tube diameter	L1	Sw1	Sw2	Price (EUR)
106-231-L	90° bulk head	6		12	14	9,82 €
106-221-L	Straight bulk head	6		17	14	5,69 €
106-241-L	Straight bulk head M6x1	6	33	17	14	5,06 €
106-243-L	Straight bulk head M10x1	6	66	17	14	9,13 €

Push-in fittings

For plastic tubes or NUT hose studs

1. Elbow (90°) push-in fittings

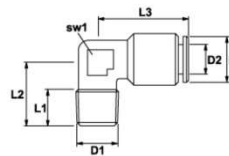

Part Number	Description	D	D1	Tube diameter	Sw1	L1	L2	L3	Price (EUR)
104-151	WEK 4-M6x1	9	M6x1	4	10	7,5	16,5	20	3,37 €
104-152	WEK 4-M8x1	9	M8x1	4	10	8	16,5	20	3,37 €
104-153	WEK 4-M10x1	9	M10x1	4	10	8	17	20	3,37 €
104-154	WEK 4-R1/8 BSP	9	R1/8 BSP	4	10	8	15	20	3,37 €
106-151	WEK 6-M6x1	12	M6x1	6	10	7,5	16,5	21	3,37 €
106-152	WEK 6-M8x1	12	M8x1	6	10	8	16,5	21	3,37 €
106-153	WEK 6-M10x1	12	M10x1	6	10	8	17	21	3,37 €
106-154	WEK 6-R1/8 BSP	12	R1/8 BSP	6	10	8	15	21	3,37 €

2. Straight push-in fittings

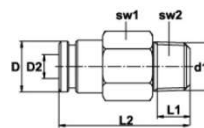

Part Number	Description	D	D1	Tube diameter	Sw1	Sw2	L1	L2	Price (EUR)
104-051	GEK 4-M6x1	9	M6x1	4	10	3	7,5	18,5	2,23 €
104-052	GEK 4-M8x1	9	M8x1	4	10	2,5	8	23	2,23 €
104-053	GEK 4-M10x1	9	M10x1	4	10	3	8	20	2,23 €
104-054	GEK 4-R1/8 BSP	9	R1/8 BSP	4	11	3	8	20	2,23 €
106-051	GEK 6-M6x1	12	M6x1	6	12	3	7,5	21,5	2,19 €
106-052	GEK 6-M8x1	12	M8x1	6	12	2,5	8	25,5	2,19 €
106-053	GEK 6-M10x1	12	M10x1	6	12	4	8	25,5	2,19 €
106-054	GEK 6-R1/8 BSP	12	R1/8 BSP	6	12	4	8	22	2,19 €

3. Elbow (90°) push-in swivel fittings

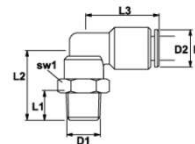

Part Number	Description	D	D1	Tube diameter	Sw1	L1	L2	L3	Price (EUR)
104-111	WEDK 4-M6x1	9	M6x1	4	13	8	20,5	20	4,53 €
104-112	WEDK 4-M8x1	9	M8x1	4	13	8	20,5	20	4,53 €
104-113	WEDK 4-M10x1	9	M10x1	4	13	8	20,5	20	4,53 €
104-114	WEDK 4-R1/8 BSP	9	R1/8 BSP	4	13	7,5	20	20	4,53 €
106-111	WEDK 6-M6x1	12	M6x1	6	13	8	20,5	21,5	4,53 €
106-112	WEDK 6-M8x1	12	M8x1	6	13	8	20,5	21,5	4,53 €
106-113	WEDK 6-M10x1	12	M10x1	6	13	8	21,5	21,5	3,71 €
106-114	WEDK 6-R1/8 BSP	12	R1/8 BSP	6	13	7,5	20,5	21,5	4,53 €

4. Straight push-in connectors

For plastic tubes or NUT hose studs

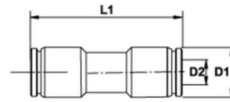

Part Number	Description	D1	Tube diameter	L1	Price (EUR)
104-110	GK 4 push-in connector	9	4	28	4,69 €
106-110	GK 6 push-in connector	12	6	31,5	4,37 €

High pressure and flexible hoses with accessories

1. High pressure hoses

Up to 600-840 bar pressure, Thermopl.Polyurethan inner, from -30° to +80°C

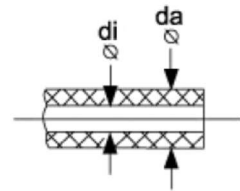

Part Number	Description	di	da	Packing	Price (EUR)
100-001	8,6x2,25MM 50M coil, filled with NLGI 2 zsírral	4	8,6	50	2,81 €
100-002	8,6x2,25MM 50M coil, empty	4	8,6	50	2,35 €
100-011	11,3x2,5MM 100M coil, filled with NLGI 2 zsírral	6,3	11,3	100	4,55 €
100-012	11,3x2,5MM 100M coil, empty	6,3	11,3	100	4,06 €

2. Screw sleeves for hose studs

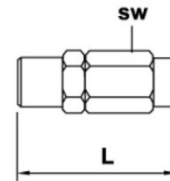

Part Number	Description	L	Sw	Price (EUR)
100-050	Screw sleeve for 8,6MM hose	28	12	1,34 €
100-050-VA	Screw sleeve for 8,6MM hose, stainless steel	28	12	Ask
100-060	Screw sleeve 11,3MM	35,8	17	3,75 €
100-060-VA	Screw sleeve 11,3MM, stainless steel	35,8	17	Ask

3. Straight hose studs

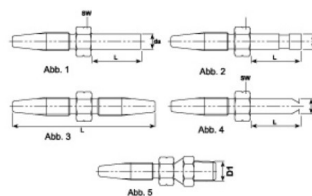

Part Number	Description	da	L	Sw	Price (EUR)
100-054-4	4MM short	4	20	10	1,61 €
100-054-NUT	6MM short, NUT	6	20	10	1,44 €
100-055		6			1,44 €
100-051-1	6MM 1/8NPT				1,44 €
100-051-NUT	6MM long, NUT	6	30	10	1,44 €
100-061	6MM short				2,00 €
100-051-VA	6MM long, stainless steel	6	30	10	Ask
100-051-8	8MM long	8	30	10	1,93 €
100-064-NUT	6MM short for 11,3 hose, NUT	6	20	12	2,81 €
100-074	8MM short for 11,3 hose	8	20	12	2,81 €
100-081	8MM long for 11,3 hose				2,81 €

4. 90° and 45° hose studs

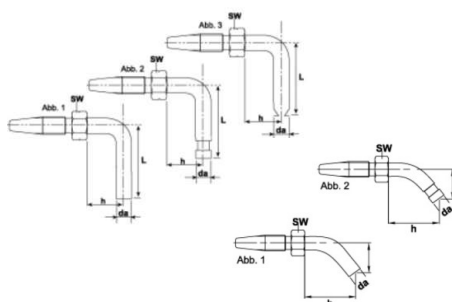

Part Number	Description	h	l	Sw	Price (EUR)
100-059-4	90° 4MM short, d=4mm	14	30	10	4,37 €
100-052	90° 6MM short	13	21	10	2,50 €
100-053-NUT	90° 6MM long, NUT	28	37	10	2,50 €
100-056-NUT	90° 6MM long, NUT				2,50 €
100-062	90° 6MM long				2,50 €
100-063	90° 6MM long				6,22 €
100-073	90° 8MM long				6,22 €
100-083	90° 10MM long				6,22 €
100-057-NUT	45° 6MM short, NUT	24	15	10	2,50 €
100-058-NUT	45° 8MM short, NUT	35	25	10	2,50 €

5. Plastic and metal tubes



Part Number	Description	da	s	di	Price (EUR/m)
100-009-25	6x1,5MM filled with NLGI 2, 25M coil	6	1,5	3	2,45 €
100-003	6x1,5MM empty, 100M coil	6	1,5	3	1,30 €
100-006	4x0,85MM black, PA12 PHL DIN73378	4	0,85	2,3	0,95 €
100-006-T	4x0,85MM transparent PA12 PHL DIN73378	4	0,85	2,3	0,96 €
104-203	Insert 4mm reinforcing socket	2,3		1,5	0,13 €
106-203	Insert 6mm reinforcing socket	3,5		2,5	0,17 €
5501201	TUBE-COPPER 4 M X0.5 (KG), pliant	4	0,5	3	4,00 €
100-111	Steel tube 6x1mm	6	1	4	2,90 €

Greasing blocks – T-drilling

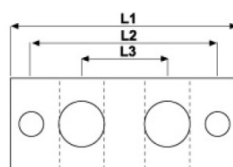

Part Number	Description	L1	L2	L3	Price (EUR)
100-211	Greasing block 1 mounting hole	30			9,69 €
100-212	Greasing block 2 mounting holes	60	50	22	12,81 €
100-213	Greasing block 3 mounting holes	80	74	22	18,75 €
100-214	Greasing block 4 mounting holes	106	96	22	23,44 €
100-215	Greasing block 5 mounting holes	128	118	22	27,81 €
100-216	Greasing block 6 mounting holes	150	140	22	31,88 €
100-218	Greasing block 8 mounting holes	194	184	22	38,13 €

Closure plugs



Part Number	Description	d1	sw	Price (EUR)
100-243	Closure plug M10x1	10X1	5	1 €
91144	Closure plug R 1/8"	1/8"		0,80 €

Filling pump, couplings, grease nipples

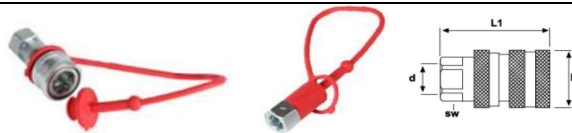

100-205-1/4	Coupling female	D-28 / d-1/4 / L1-57mm	26,56 €
100-205-3/8	Coupling female	D-28 / d-3/8 / L1-64mm	26,56 €



100-200	Filling connection: for Beka-Max, Vogel, Komatsu, és Caterpillar pumps	M20x1,5	23,44 €
100-208	Filling connection: for Dropsa, Lincoln pumps	M22x1,5	23,44 €
100-201	Filling pump for cartridge		77,79 €



	Straight grease nipple, M5x0,8	H1 M5x0,8	0,20 €
	Straight grease nipple, M6x1	H1 M6x1	0,20 €
	Straight grease nipple, M8x1	H1 M8x1	0,20 €
	Straight grease nipple, M10x1	H1 M10x1	0,20 €
	Straight grease nipple, M12x1	H1 M12x1	0,42 €
	Straight grease nipple, R1/8"	H1 R1/8"	0,20 €
	Straight grease nipple, R1/4"	H1 R1/4"	0,42 €
	Grease nipple 45°, M5x0,8	H2 M5x0,8	0,55 €
	Grease nipple 45°, M6x1	H2 M6x1	0,39 €
	Grease nipple 45°, M8x1	H2 M8x1	0,39 €
	Grease nipple 45°, M10x1	H2 M10x1	0,39 €
	Grease nipple 45°, M12x1	H2 M12x1	1,23 €
	Grease nipple 45°, R1/8"	H2 R1/8"	0,55 €
	Grease nipple 45°, R1/4"	H2 R1/4"	1,23 €
	Grease nipple 90°, M5x0,8	H3 M5x0,8	0,39 €
	Grease nipple 90°, M6x1	H3 M6x1	0,39 €
	Grease nipple 90°, M8x1	H3 M8x1	0,39 €
	Grease nipple 90°, M10x1	H3 M10x1	0,39 €
	Grease nipple 90°, M12x1	H3 M12x1	1,23 €
	Grease nipple 90°, R1/8"	H3 R1/8"	0,55 €
	Grease nipple 90°, R1/4"	H3 R1/4"	1,23 €
	Dust cover for grease nipple		0,11 €
12 631	4-jaw grease fitting	Ø 15	2,10 €
12 052	Grease fitting for button head	Ø 10	2,58 €
12 004	Grease fitting for button head	Ø 16	3,23 €
12 062	Grease fitting for button head, copper	Ø 16	8,07 €
12 003	Grease fitting for concave head	M10x1	0,97 €

Adapters, extension pieces

Adapters



Part Number	Description	Cső d	d1	d2	L1	L2	L3	sw	Price (EUR)
100-120	M8x1 / M6x1 / 18MM D4	4	6x1	8x1	18	8	10	11	1,79 €
100-130	M8x1 / M8x1 / 18MM D4	4	8x1	8x1	18	8	10	11	1,33 €
100-132	M8x1 / M8x1 / 32MM D4	4	8x1	8x1	32	22	10	11	2,40 €
100-135	M8x1 / M8x1 / 62,5MM D4	4	8x1	8x1	62,5	62,5	10	11	3,04 €
100-137	M8x1 / M10x1 / 23MM D6	6	8x1	10x1	23	12	11	13	2,14 €
100-140	M10x1 / M8x1 / 18MM D4	4	10x1	8x1	18	8	10	11	1,58 €
100-142	M10x1 / M10x1 / 18MM D6	6	10x1	10x1	18	7	11	13	1,10 €
100-141	M10x1 / M10x1 / 23MM D6	6	10x1	10x1	23	12	11	13	1,58 €
100-145	M10x1 / M10x1 / 35MM D6	6	10x1	10x1	35	24	11	13	2,19 €
100-143	M10x1 / M10x1 / 40MM D6	6	10x1	10x1	40	29	11	13	2,50 €
100-146	M10x1 / M10x1 / 50MM D6	6	10x1	10x1	50	39	11	13	3,09 €
100-151	R1/8 / M10x1 / 18MM D6		1/8"	10x1	18	7	11	13	1,33 €
100-152	R1/8 / R1/8 / 18MM D6	6	1/8"	1/8"	18	7	11	13	1,58 €
100-155	R1/8 / M8x1 / 18MM D4	4	1/8"	8x1	18	7	11	13	1,33 €
100-148	R1/8 / R1/8 / 23MM D6		1/8"	1/8"	23	12	11	13	1,58 €
100-149	R1/8 / R1/8 / 35MM D6		1/8"	1/8"	35	23	12	13	3,19 €
100-154	B R1/8 / K R1/8 / 45MM D6	6	1/8"	1/8"	45		12	13	2,76 €
100-153	R1/8 / R1/8 / 50MM D6		1/8"	1/8"	50	38	12	13	3,09 €
100-144	R1/4 / M10x1 / 20MM D6	6	1/4"	10x1	20	9	11	17	2,57 €
100-147	R1/4 / R1/8 / 20MM D6		1/4"	1/8"	20	9	11	17	2,57 €
100-160	R3/8 / R1/4 / 20MM D7		1/4"	3/8"	27	11	16	22	2,32 €



1. Socket unions for double cone drive and DD cutting rings

Part Number	Description	D	D1	L	sw	Price (EUR)
104-215-MS	Cutting ring 4MM, DD	4		5,5		0,20 €
106-215-MS	Cutting ring 6MM, DD	6		7		0,25 €
104-205	Socket union M8x1	4	8x1	10	8	0,61 €
106-205	Socket union M10x1	6	10x1	14	10	0,50 €
92052	Socket union R 1/8"	6	1/8"	14	10	0,58 €
91354	Socket union R 5/16"	4	5/16"			0,58 €

2. 45°Adapters

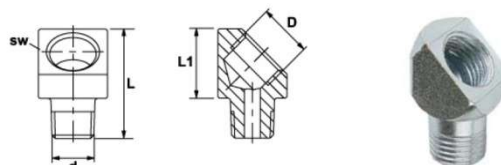

Part Number	Description	D	d	L	L1	sw	Price (EUR)
100-822	M8x1 / M8x1	8x1	8x1	23	13	13	2,23 €
100-833	M10x1 / M10x1	10x1	10x1	23	13	13	2,23 €
100-844	R1/8 / R1/8	1/8"	1/8"	23	13	13	2,23 €
100-855	R1/4 K / R1/4 BSP B	1/4"	1/4"	33	18	17	3,59 €

3. 90°Adapters

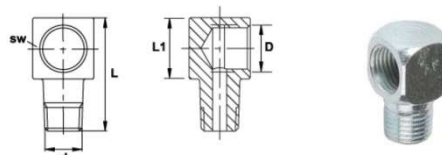

Part Number	Description	D	d	L	L1	sw	Price (EUR)
100-721	M8x1 K / M6x1 B	8x1	6x1	23	13	12	2,23 €
100-722	M8x1 K / M8x1 B	8x1	8x1	23	13	12	2,23 €
100-723	M8x1 K / M10x1 B	8x1	10x1	23	13	12	2,23 €
100-733	M10x1 K / M10x1 B	10x1	10x1	23	13	13	2,23 €
100-744	R1/8 BSP K / R1/8 BSP B	1/8"	1/8"	23	13	13	2,23 €
100-724	M8x1 K / R1/8 BSP B	8x1	1/8"	23	13	12	2,23 €
100-755	R1/4 K / R1/4 BSP B	1/4"	1/4"	33	18	17	3,77 €

4. Rubber lined tube clamps

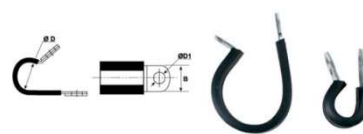

Part Number	Leírás Description	D1	B	Price (EUR)
100-506	Rubber tube clamp 6mm	5,3	12	0,78 €
100-510	Rubber tube clamp 9mm	5,3	12	0,78 €
100-512	Rubber tube clamp 12mm	5,3	12	0,78 €

Plastic helix, protective hose



Part Number	Description			Price (EUR)
100-030	Protective hose 10MM	Gégecső		1,41 €
100-031	Protective hose 12MM	Gégecső		1,41 €
100-040	Plastic helix 6MM	Bandázs		1,19 €
100-041	Plastic helix 11,5MM	Bandázs		1,36 €

Elektro-kémiai adagolású kenőpatronok

1. PULSARLUBE „S”

Spring type lubricator, -23°C + 120°C, 1/4" connection, d67mm x 129mm



Part Number	Name	Description	Price (EUR)
S100/EMPTY	100 CC	Without grease	18,00 €

1000RC-1	1 point remote set - for 30cm distance, with console	1 Point Remote (Pulsarlube V)	22,00 €
----------	--	-------------------------------	---------

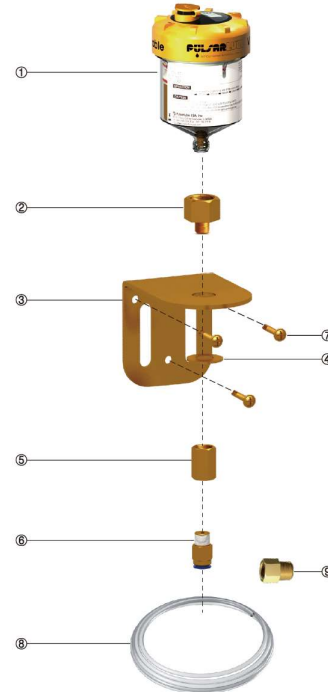

PULSARLUBE „E”

With gas, 1-3-6-12 monts, -20°C + 55°C, 5bar, EX T4 + IP65



Part Number	Name	Description	Price (EUR)
E60/EMPTY	60 cc	Without grease	18,50 €
E120/EMPTY	120 cc	Without grease	19,90 €
E240/EMPTY	240 CC	Without grease	21,90 €

Elektro-mechanical greasing unit



1. PULSARLUBE „M”

Elektro-mechanical, -15°C +60°C Alkali; -40°C +60°C Lithium, 1/2 - 24 hónap, 30/60 bar, IP54

Part Number	Name	Description	Price (EUR)
M60/EMPTY	60 cc	Empty	131,80 €
M125/EMPTY	125 CC	Empty	133,90 €
M250/EMPTY	250 CC	Empty	137,90 €
M500/EMPTY	500 CC	Empty	162,90 €

a) Kits for PULSARLUBE „M”

Part Number	Name	Description	Price (EUR)
SV60/EMPTY	60 cc Alkali	Empty	11,00 €
SV125/EMPTY	125 cc Alkali	Empty	12,00 €
SV250/EMPTY	250 cc Alkali	Empty	14,00 €
SV502/EMPTY	500 cc Alkali	Empty	16,00 €
SV503/EMPTY	500 cc Lithium	Empty	39,00 €

2. PULSARLUBE „MSP” - Kits

synchronized version – EXTERNAL POWER SUPPLY, AC 110- 440V 0,5W vagy DC 24V, 5,0V 2A output signal, Red-LED display "ON"

Part Number	Name	Description	Price (EUR)
OL500/MSP/VAC	500 cc	complete kit, Alkali	219,00 €
OL500/MSP/VDC	500 cc	complete kit, Alkali	209,00 €
MSP 500/MAIN/VAC	500 cc	complete kit, Alkali	205,00 €
MSP 500/MAIN/VDC	500 cc	complete kit, Alkali	195,00 €
MSP 250/MAIN/VAC	250 cc	complete kit, Alkali	179,00 €
MSP 250/MAIN/VDC	250 cc	complete kit, Alkali	169,00 €
MSP 125/MAIN/VAC	125 cc	complete kit, Alkali	169,00 €
MSP 125/MAIN/VDC	125 cc	complete kit, Alkali	166,00 €
MSP 60/MAIN/VAC	60 cc	complete kit, Alkali	169,00 €
MSP 60/MAIN/VDC	60 cc	complete kit, Alkali	159,00 €

3. PULSARLUBE "OL"

Oil lubricator, -15°C +60°C Alkali, -40°C + 60°C Lithium, 1/2 - 24 hónap, 10bar, 150-10000 cSt

OL500	500 cc	complete kit, Alkali	170,00 €
-------	--------	----------------------	----------

Accessories for elektro-mechanical és elektro-chemical units

Part Number	Name	Description	Price (EUR)
B 001		Standard battery pack (Alkaline)	9,00 €
LB 001		Lithium battery pack (blue color)	29,00 €
H 125		M 125 top housing	10,5 €
H 250		M 250 top housing	13,00 €
H 500		M 500 top housing	15,00 €
D 125		125 cc dust cover, PVC	2,50 €
D 250		250 cc dust cover, PVC	3,50 €
D 500		500 cc dust cover, PVC	4,50 €
P 125		Grease pouch 125 cc	2,50 €
P 250		Grease pouch 250 cc	3,50 €
P 501		Grease pouch 500 cc	4,50 €

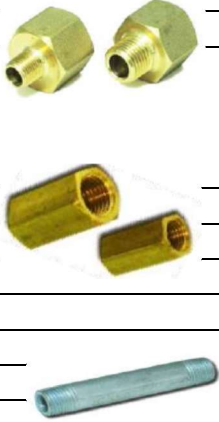
VDC		External Power Supplier for MSP	45,00 €
			37,00 €
1000RC-1	M / M-EX / MSP	1 Point Remote (Pulsarlube C, V models)	20,00 €
1000RO-1		Single Point Remote Install Kit for Oil (Low Temperature)	30,00 €
1250RC-1		1 Point Remote (Pulsarlube M)	25,00 €
1250MD-2		2 Point Remote&Multi (Pulsarlube M)	110,00 €
1250MD-3		3 Point Remote&Multi (Pulsarlube M)	125,00 €
1250MD-4		4 Point Remote&Multi (Pulsarlube M)	133,00 €
1250MD-5		5 Point Remote&Multi (Pulsarlube M)	147,00 €
1250MD-6		6 Point Remote&Multi (Pulsarlube M)	156,00 €
1250MD-7		7 Point Remote&Multi (Pulsarlube M)	168,00 €
1250MD-8		8 Point Remote&Multi (Pulsarlube M)	175,00 €
1250RO-1		1 Point Remote (OL500)	20,00 €
1250RO-2		2 Point Remote&Multi (OL500)	50,00 €
1250RO-3		3 Point Remote&Multi (OL500)	60,00 €
1250RO-4		4 Point Remote&Multi (OL500)	70,00 €
2000RC-1			14,00 €
C030			37,00 €
C031			37,00 €
C032			82,00 €
C033			68,00 €
C034			13,00 €
C035			13,00 €
A 001		Reducer, 3/8" > 1/4"	2,50 €
A 002		Reducer, 3/8" > 1/8"	2,50 €
A 003		Reducer, 1/4" F x M6 x 1.0 M Adaptor (Steel)	3,50 €
A 004		Reducer, 1/4" F x M8 x 1.25 M Adaptor (Steel)	3,50 €
A 005		Reducer, 1/4" F x 1/8" M Adaptor (Brass)	3,50 €
A 006		Reducer, 1/4" F x 3/8" M Adaptor (Brass)	3,50 €
A 028		Reducer, 1/4" F x 1/4" M Adaptor (Brass)	3,50 €
A 030		Reducer, 1/4" F x M8 x 1.0 M Adaptor (Steel)	3,50 €
A 031		Reducer, 1/4" F x M10 x 1.0 M Adaptor (Brass)	3,50 €
A 032		Reducer, 1/4" F x M10 x 1.5 M Adaptor (Brass)	3,50 €
A 033		Reducer, 1/4" F x M12 x 1.5 M Adaptor (Brass)	3,50 €
A 034		Reducer, 1/4" F x M12 x 1.75 M Adaptor (Brass)	3,50 €

A 011		Socket 1/4" – 1/4"	3,50 €
A 012		Socket 1/8" – 1/8"	1,50 €
A 106		Pipe for divider block 1/8 x 1/8 x 50mm	2,00 €
A 107		Pipe for divider block 1/8 x 1/8 x 100mm	2,50 €
A 239		Tube Fitting, Push-In Type, PC8-PT1/8"M	3,00 €
A 240		Tube Fitting, Push-In Type, PC6-PT1/8"M	3,00 €
A 019		90° Elbow, 1/4"F X 1/4"F Adaptor (Brass)	3,50 €
A 020		90° Elbow, 1/8"F X 1/8"F Adaptor (Brass)	3,00 €
A 021		90° Elbow, 1/4"M X 1/4"F Adaptor (Brass)	3,00 €
A 022		90° Elbow, 1/8"M X 1/8"F Adaptor (Brass)	2,50 €
A 023		45° Elbow, 1/4"M X 1/4"F Adaptor (Brass)	3,50 €
A 024		45° Elbow, 1/8"M X 1/8"F Adaptor (Brass)	3,00 €
A 026		Reducer, 1/8"F x M8 X 1.25 M Adaptor (Brass)	2,50 €
A 027		Reducer, 1/8"F X UNF 1/4"(6.35mm) M Adaptor (Brass)	3,00 €
A 231		90° Tube Fitting, Push-In Type, PC8-PT1/8"M	2,50 €
A 232		90° Tube Fitting, Push-In Type, PC6-PT1/8"M	2,00 €
A 233		90° Tube Fitting, Push-In Type, PC8-PT1/4"M	2,00 €
A 234		90° Tube Fitting, Push-In Type, PC6-PT1/4"M	2,00 €
A 235		Tube Fitting, Push-In Type, PC8-PT3/8"M	2,00 €
A 236		Tube Fitting, Push-In Type, PC6-PT3/8"M	2,00 €
A 237		Tube Fitting, Push-In Type, PC8-PT1/4"M	2,00 €
A 238		Tube Fitting, Push-In Type, PC6-PT1/4"M	2,00 €
A 239-90		Push-in fitting connector : PC8-PT 1/8"M 90Deg	3,00 €
A 240-90		Push-in fitting connector : PC6-PT 1/8"M 90Deg	3,00 €
A 245		Push-in fitting 8mm x 1/8" straight	Ask
A 245-90		Push-in fitting 8mm x 1/8" elbow	Ask
A 212-1		5/16" (8mm) distribution tubing, filled, 1 m	4,00 €
A 214-1		1/4" (6mm) distribution tubing, filled, 3 m	5,50 €
B 014		Cross-Port Bridge, horizontal	12,00 €
B 002		Mounting bracket, „L" Shape	5,00 €
B 003		Oil Brush Bracket, „L" Shape	7,50 €
B 004		Adjustable Stainless Steel Clamp (Max. Dia. 92mm)	21,50 €
B 005		Heavy Duty Stainless Steel Mounting Bracket, "L" Shape	9,00 €
B 006		Heavy Duty Stainless Steel Mounting Clamp & Bracket Kit	14,50 €
B 057		Washer	0,30 €
B 058		Tooth Washer	0,30 €
B 051			0,20 €
B 052			0,30 €
C 001		Oil Brush 2", flat nylon 1/8"	19,00 €
C 013		Oil Brush, 2" Flat Stainless Steel, NPT1/8"M	52,00 €
C 002		Oil Brush 1", d20mm, nylon 1/8"	19,00 €
C 014		Oil Brush, 1" Round Stainless Steel, NPT1/8"M	43,00 €
C 003		Disztributor 6(4P) M8 x 1P	9,00 €
C 004		Resistance Valve	5,00 €
C 005		Plug M8 x 1P	1,00 €
C 006		Reducer, 1/8" > M8 x 1P	3,00 €

Automatic Greasing systems

1. Dropsa Bravo greasing pump

Delivery: 2,8ccm/min, 9 - 36V, min. 3 kg, timer/cycle controlling

Part Number	Description	Comment	Price (EUR)
888117	Tank cover - Dropsa Bravo		26,70 €
888116	Modular tank	Broadenable up to 21 kg	82,26 €
888058c	Pump unit	Built-in safety valve	99,44 €
3314445	Membrane keypad		36,74 €
1643133	PC Board		138,39 €
100-208	Filling connection		23,463 €
100-201	Filling pump		77,79 €



2. Lincoln P203 greasing pump

Delivery: 2,8ccm/min, 12V or 24V, min. 2 kg, timer-controlling

Part Number	Description	Comment	Price (EUR)
544-31996-1	Tank 2kb XN		96,45 €
600-26876-2	Pump unit		78,06 €
236-13891-1	Control panel		113,53 €
624-28894-1	Safety valve 350bar		67,88 €



3. Bekamax EP 1 greasing pump

Delivery: 1,7 ccm/min, 12V or 24V, min. 1,9 kg, timer-controlling

Part Number	Description	Comment	Price (EUR)
	Tank 1,9 Ltr		42,40 €
	Pump unit PE120		102,00 €
40201	Pump unit + safety valve PE 120		132,00 €
	Safety valve		54,57 €
	Control unit in housing		377,50 €
	Plastic housing		75,60 €



4. Vogel KFGS greasing pump (Komatsu, Caterpillar)

Delivery: 1,7 ccm/min, 12V or 24V, min. 3 kg, timer-controlling

Part Number	Description	Comment	Price (EUR)
	Tank 3 L		152,00 €
	Tank top		14,00 €
8502221	Pump unit		40,00 €
	Internal control unit		283,00 €
	Push-button display		121,00 €



Automatic greasing accessories

1. Other accessories

Cikkszám	Leírás	Ár / Price
Part Number	Description	EUR
1655305	Ultrasensor SMX	159,00 €
1655306	Ultrasensor SMP	159,00 €
39999	Ultraszensor connector M12x1	9,20 €
6265	Manifold 1 Way 1/8"	5,87 €
6266	Manifold single row 2 way	7,34 €
6267	Manifold single row 3 way	8,80 €
6268	Manifold single row 4 way	10,05 €
6269	Manifold single row 5 way	11,55 €
6274	Manifold single row 6 way	12,98 €
6210	Manifold 12 ways 1/8"	27,97 €
91144	SMX close plug	0,80 €

Kenőanyagok

1. Greases

Part Number	Description	Packs (liter/kg)	Price (L/kg)	Price (EUR)
Beslux Plex H2	High temperature grease	25 kg	13,00 €	65,00 €
	High temperature grease	45 kg	12,00 €	540,00 €
Precision XL EP-00		17 kg	12,80 €	217,60 €
		54 kg	12,88 €	695,52 €
		175 kg	12,42 €	2 173,50 €
Precision XL EP-2	The PRECISION XL EP00 is NLGI 00 is a fluid-lithium based grease. Temperature: between -35°C/-31°F és 100°C/212°F. Proper for: Groeneveld, Dropsa, Lincoln, Vogel, Beka-Max, Komatsu és Caterpillar	0,4 kg	1,60 €	4,00 €
		17 kg	7,00 €	119,00 €
		54 kg	6,70 €	361,80 €
		175 kg	6,40 €	1 120,00 €
Brugarolas G.A.N 850 EP-0	Universal lithium grease. High quality and good greasing. Temperature: between -25°C-től +120°C.	18 kg	6,00 €	108,00 €
Brugarolas G.A.N 850 EP-2	Universal lithium grease. High quality and good greasing. Temperature: between -25°C-től +120°C.	18 kg	6,00 €	108,00 €
		5 kg	7,00 €	35,00 €

2. Lubricant

Beslux Atox 68	Chain lubrication oil	5 L	9,10 €	45,50 €
----------------	-----------------------	-----	--------	---------

Additional information

- Prices are net prices – without VAT
- The order can be sent apiece or linear meters
- Price list does not include the package and delivery cost
 - Delivery cost: 15 € + VAT per 10 kg
 - Max weight of a package: 40 kg
- Delivery time:
 - In case of a standard product: 1 week
- Order sending: every workday – orders arrived until 1 p.m according to stock - with GLS.

We are waiting your order by

- Email info@euroscale.hu

Please give us the part number and the ordered quantity in your order!

Information for choosing items:

+3670 621 0346 or **+3670 341 5067**

Other customized parts/services can be ordered:

- Greasing system diagnostics: ranging pumps and deviders, revision, plugging solving

For other relating products please contact us!